

LT455/450 □ U/W Series Ceramic Filters LT455/450 □ U/W 系列通訊機用陶瓷濾波器

<Technical Characteristics 技術特性>

Part Number 型號		Center Frequency 頻率範圍 (kHz)	Insertion Loss max 插入損耗 (dB)	Pass Band Ripple max. 通帶波動(dB)	6dB Bandwidth 6 分貝帶寬 (kHz) min	40dB Bandwidth 40 分貝帶寬 (kHz) max (LT455 □ U)	50dB Bandwidth 50 分貝帶寬 (kHz) max (LT455 □ W)	Stop Band Attenuation Fo±100kHz (dB) min. 阻帶衰耗		Input/Output Impedance (ohms) 輸入/輸出阻抗
								LT455 □ U	LT455 □ W	
LT455BU	LT455BW	455 ±2.0	4	2	±5	±30	±30	28	40	1500
LT455CU	LT455CW	455 ±2.0	4	2	±2.5	±4	±4	28	40	1500
LT455DU	LT455DW	455 ±.5	4	2	±0	±20	±20	28	40	1500
LT455EU	LT455EW	455 ±.5	6	2	±7.5	±5	±5	28	40	1500
LT455FU	LT455FW	455 ±.5	6	2	±6	±2.5	±2.5	28	40	2000
LT455GU	LT455GW	455 ±.5	6	2	±.5	±0	±0	28	40	2000
LT455HU	LT455HW	455 ±.0	6	2	±3	±9	±9	28	40	2000
LT455IU	LT455IW	455 ±.0	6	2	±2	±7.5	±7.5	28	40	2000
LT455HTU	LT455HTW	455 ±.0	6	2	±3	±9	±9	35	60	2000

**Center Frequency 450kHz is also Available **

<Outline Dimensions 尺寸>

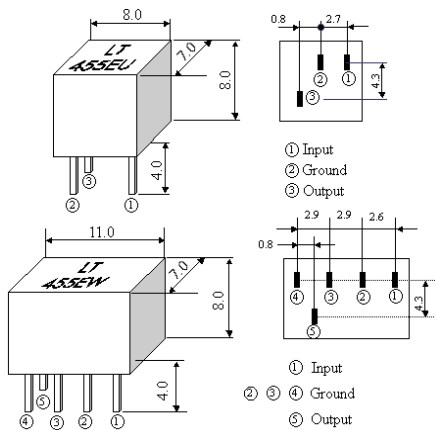

<LT455/450 □ U/W Series Test Circuit 測試電路圖>

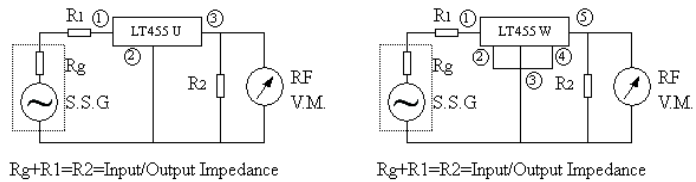

<Characteristics 特性曲線>

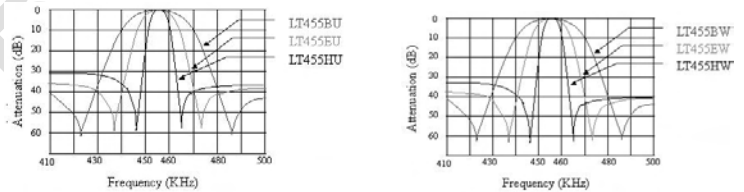

LT □ MB SERIES FOR TV/VCR STAGE (Murata SFE MB series Compatible) LT □ MB 系列電視機/錄影機用陶瓷濾波器

<Outline Dimensions 尺寸>

<Characteristics 特性曲線>

<Technical Characteristics 技術特性>

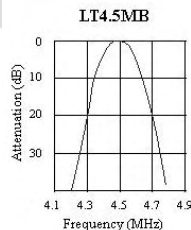
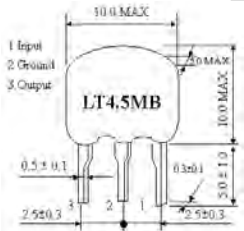

<Test Circuit 測試電路圖>

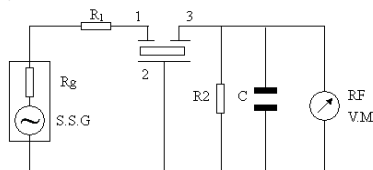

$R_g + R_1 = R_2 = \text{Input and Output Impedance}$
C = 10pF (Including Stray Capacitance and Input Capacitance of RF Voltmeter)

Part Number 型號	LT4.5MB	LT5.5MB	LT6.0MB	LT6.5MB
Nominal Center Frequency (fn)(MHz) 標稱中心頻率	4.500	5.500	6.000	6.500
3dB Bandwidth 3 分貝帶寬(kHz) min	$f_n \pm 5$	$f_n \pm 7.5$	$f_n \pm 10$	$f_n \pm 10$
20dB Bandwidth 20 分貝帶寬(kHz) max	530	550	600	630
Insertion Loss max 插入損耗 (dB)	6.0	6.0	6.0	6.0
Spurious Attenuation 阻帶衰耗(dB) min.	20 (4.5+0.8MHz) 20 (4.5-1.0MHz)	25 (5.5 ±1MHz)	25 (6.0 ±1MHz)	25 (6.5+1MHz) 30 (6.5-1MHz)
Input/Output Impedance (ohms) 輸入/輸出阻抗	1000	600	470	470

LTM455/450 □ U/W Series Ceramic Filters LTM455/450 □ U/W 系列通訊機用陶瓷濾波器

<Technical Characteristics 技術特性>

Part Number 型號	Center Frequency 頻率範圍 (kHz)	Insertion Loss max 插入損耗 (dB)	Pass Band Ripple max. 通帶波動(dB)	6dB Bandwidth 6分貝帶寬 (kHz) min	40dB Bandwidth 40分貝帶寬 (kHz) max (LTM455 □ U)	50dB Bandwidth 50分貝帶寬 (kHz) max (LTM455 □ W)	Stop Band Attenuation Fo+/-100kHz (dB) min. 阻帶衰耗		Input/Output Impedance (ohms) 輸入/輸出阻抗	
							LTM455 □ U	LTM455 □ W		
LTM455BU	LTM455BW	455 ±2.0	4	2	±15	±30	±30	28	40	1500
LTM455CU	LTM455CW	455 ±2.0	4	2	±2.5	±24	±24	28	40	1500
LTM455DU	LTM455DW	455 ±1.5	4	2	±10	±20	±20	28	40	1500
LTM455EU	LTM455EW	455 ±1.5	6	2	±7.5	±15	±15	28	40	1500
LTM455FU	LTM455FW	455 ±1.5	6	2	±6	±2.5	±2.5	28	40	2000
LTM455GU	LTM455GW	455 ±1.5	6	2	±4.5	±10	±10	28	40	2000
LTM455HU	LTM455HW	455 ±1.0	6	2	±3	±9	±9	28	40	2000
LTM455IU	LTM455IW	455 ±1.0	6	2	±2	±7.5	±7.5	28	40	2000
LTM455HTU	LTM455HTW	455 ±1.0	6	2	±3	±9	±9	35	60	2000

**Center Frequency 450kHz is also Available **

<Outline Dimensions 尺寸>

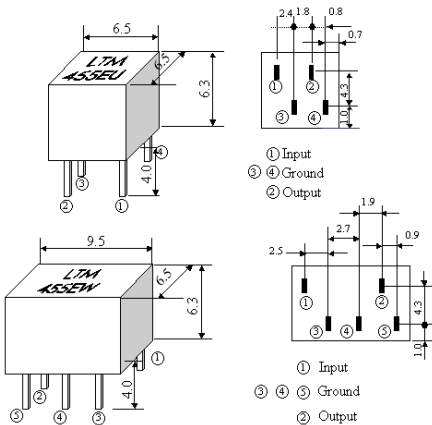

<LTM455/450 □ U/W Series Test Circuit 電路圖>

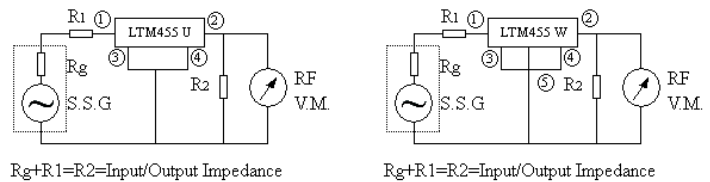

<Characteristics 特性曲線>

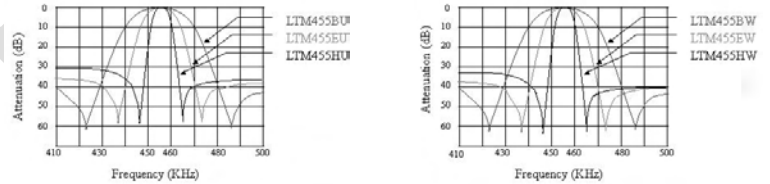

LTS □ MCB SERIES FOR TV/VCR STAGE (Murata SFSH MCB/MDB series Compatible) LTS □ MCB 系列電視機/錄影機用陶瓷濾波器

<Outline Dimensions 尺寸> <Characteristics 特性曲線>

<Technical Characteristics 技術特性>

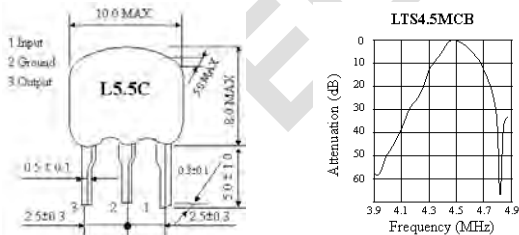

<Test Circuit 電路圖>

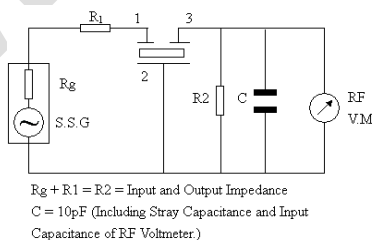

Part Number 型號	LTS 4.5MCB	LTS 4.5MDB	LTS 5.5MCB	LTS 5.5MDB	LTS 6.0MCB	LTS 6.0MDB	LTS 6.5MCB	LTS6.5 MDB
Nominal Center Frequency (fn)(MHz) 標稱中心頻率	4.500	4.500	5.500	5.500	6.0	6.0	6.5	6.5
3dB Bandwidth 3分貝帶寬(kHz) min	fn ±60	fn ±70	fn ±60	fn ±80	fn ±60	fn ±80	fn ±70	fn ±80
20dB Bandwidth 20分貝帶寬(kHz) max	600	750	600	750	600	750	650	800
Insertion Loss max 插入損耗 (dB)	6.0	6.0	6.0	6.0	6.0	6.0	6.0	6.0
Spurious Attenuation 阻帶衰耗(dB) min.	30 (0~fn)	30 (0~fn)	30 (0~fn)	30 (0~fn)	30 (0~fn)	30 (0~fn)	30 (0~fn)	30 (0~fn)
Input/Output Impedance (ohms) 輸入/輸出阻抗	1000	1000	600	600	470	470	470	470